

Catalogue

4 INCH SUBMERSIBLE PUMPS

Small-scale Water Supply



hektor
PUMPS



hektor
PUMPS





4 INCH SUBMERSIBLE PUMPS

Small-scale Water Supply

4 INCH SUBMERSIBLE PUMPS

Small-scale Water Supply



- Capacity up to 24 m³/h
- Maximum Total Head 353 m.
- Maximum water temperature 35 °C
- Max. outer diameter 98 mm (Inc. cable guard)
- Maximum tolerable sand content 50g/m³
- Discharge Connection >1¼", 1½", 2"
- Long life and easy installation
- Connection complying NEMA standards

4" Submersible Pumps Parts & Materials

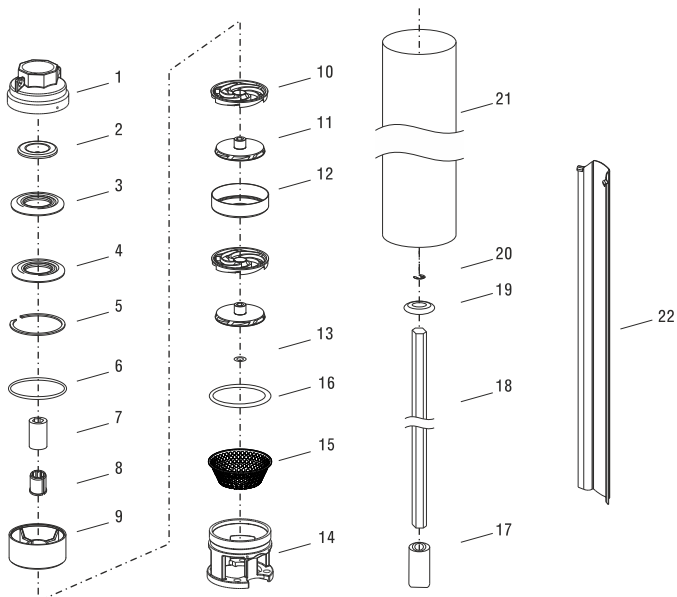

No	Part Name	Material
1	Discharge Head	Casting Stainless Steel (AISI 304)
2	Valve Disc	Stainless Steel (AISI 304)
3	Valve Seat Retainer	Stainless Steel (AISI 304)
4	Valve Seat	Stainless Steel (AISI 304)
5	Valve Locking Ring	Stainless Steel (AISI 304)
6	Adapter Ring	Noryl
7	Bushing	Noryl
8	Bearing Spacer	Polyurethane
9	Valve Housing	Noryl
10	Diffuser	PC, 20% Glass Fiber Reinforced, Natural
11	Impeller	Noryl
12	Diffuser Casing	Stainless Steel (AISI 304)
13	Shim	Stainless Steel (AISI 304)
14	Suction Case	Stainless Steel (AISI 304)
15	Strainer	Stainless Steel (AISI 304)
16	O-ring	Rubber
17	Coupling	Stainless Steel (AISI 316)
18	Shaft	Stainless Steel (AISI 420)
19	Washer	Stainless Steel (AISI 304)
20	Shim	Stainless Steel (AISI 304)
21	Pump Casing	Stainless Steel (AISI 304)
22	Cable Guard	Stainless Steel (AISI 304)

95 RN 01

4 Inch Submersible Pumps (50 Hz)

6 Vanes / 2900 Rpm (CCW) / 98mm Diameter / BSP - NPT 1¼" Outlet Connection Diameter / 11 mm Shaft Diameter

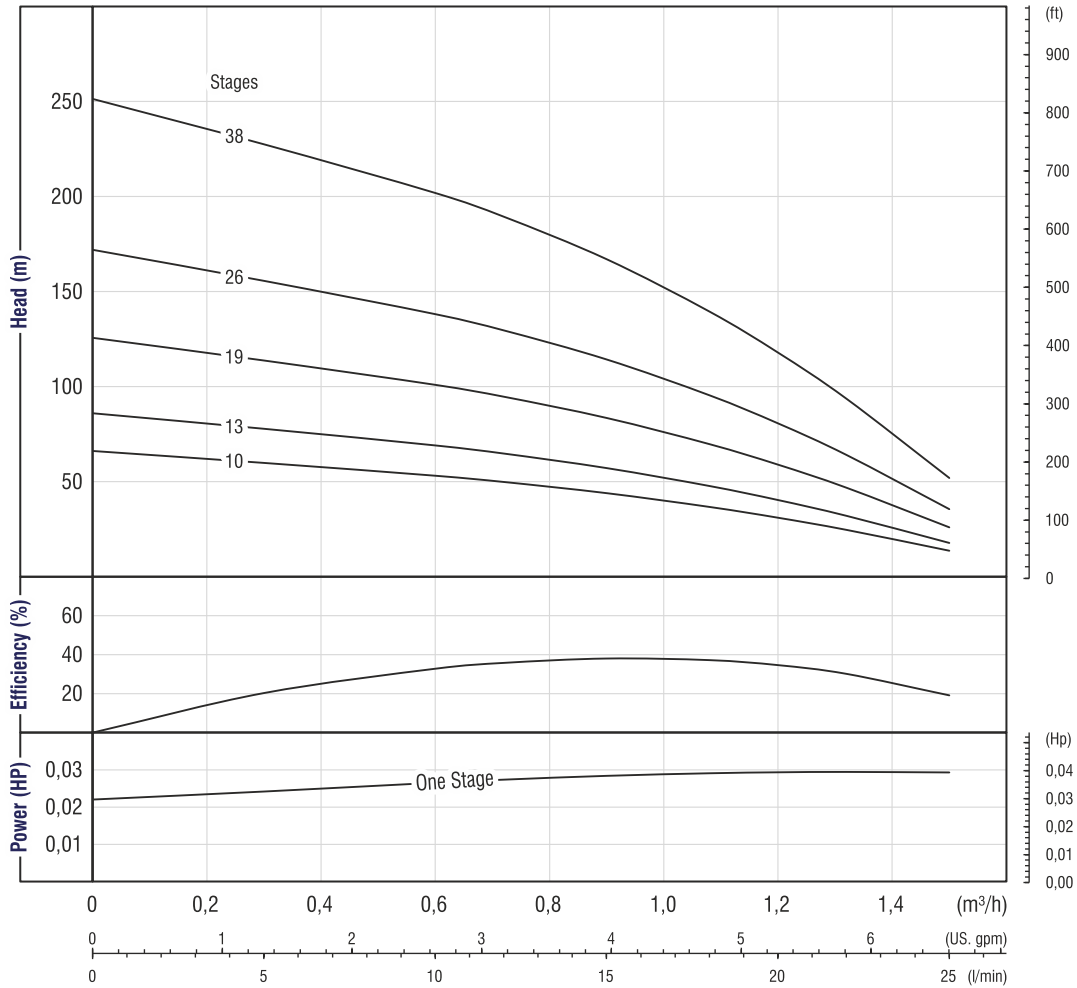

Due to continuous improvement in design we reserve the right to amend specifications or data without prior notice.

Technical Data

Pump Code	Stage	Motor Power		Length mm	Weight kg	m³/h l/min	Head (m)								
		HP	kW				0	0,3	0,6	0,7	0,9	1,1	1,2	1,3	1,5
				0	5		10	12	15	18	20	22	25		
95 RN 01 / 10	10	0,5	0,37	327	3,3	Head (m)	67	60	54	50	44	38	31	26	14
95 RN 01 / 13	13	0,5	0,37	381	3,7		87	79	70	66	58	49	40	32	19
95 RN 01 / 19	19	0,75	0,55	486	4,7		127	115	101	96	85	70	61	48	27
95 RN 01 / 26	26	1	0,75	648	5,8		172	157	140	130	115	96	81	65	37
95 RN 01 / 38	38	1,5	1,1	911	9,2		251	229	203	191	169	138	119	95	53

95 RN 02

4 Inch Submersible Pumps (50 Hz)

7 Vanes / 2900 Rpm (CCW) / 98mm Diameter / BSP - NPT 1 1/4" Outlet Connection Diameter / 11 mm Shaft Diameter

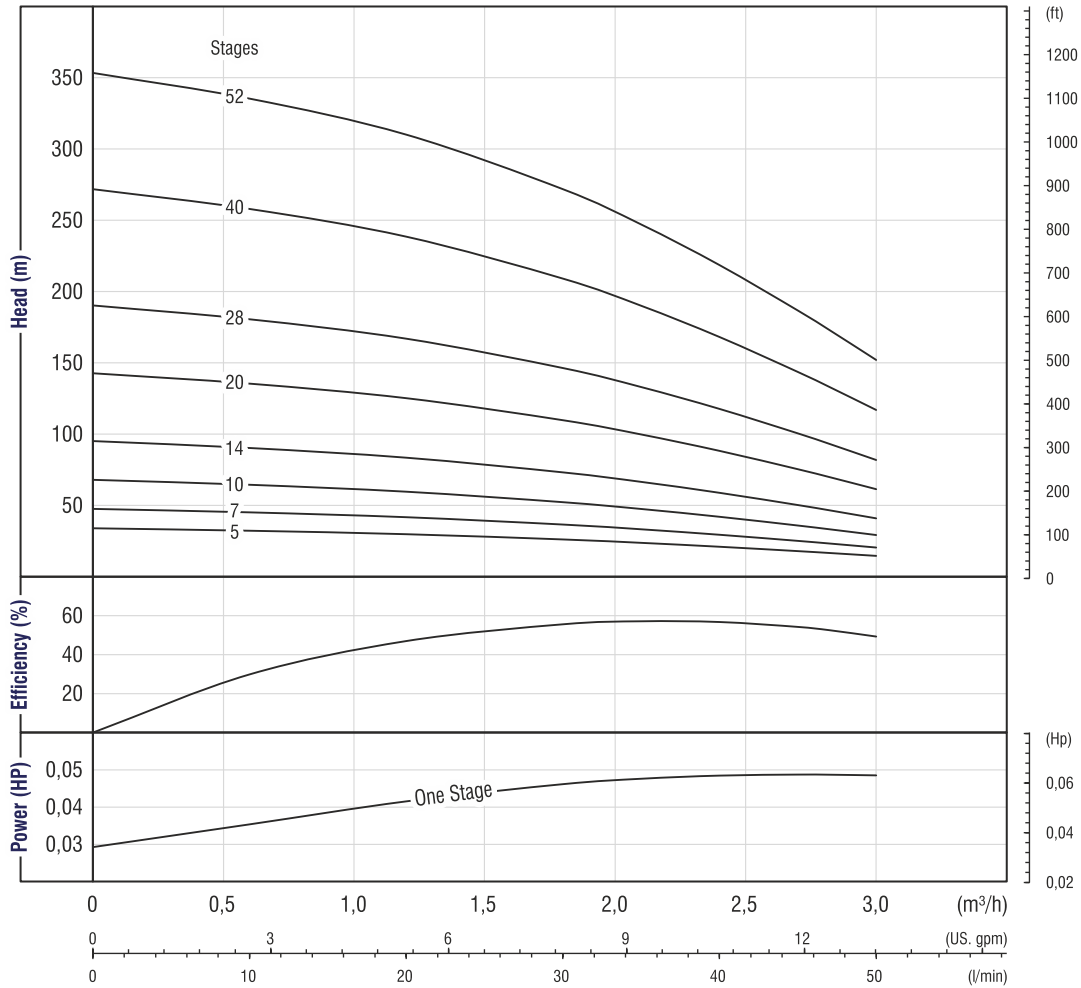

Due to continuous improvement in design we reserve the right to amend specifications or data without prior notice.

Technical Data

Pump Code	Stage	Motor Power		Length mm	Weight kg	m³/h l/min	0	0,6	1,2	1,8	2,1	2,4	2,7	2,82	3,0
		HP	kW				0	10	20	30	35	40	45	47	50
95 RN 02 / 05	5	0,5	0,37	234	2,5	Head (m)	34	32	30	27	24	21	19	18	16
95 RN 02 / 07	7	0,5	0,37	268	2,8		49	46	42	38	33	29	26	23	20
95 RN 02 / 10	10	0,75	0,55	321	3,3		69	65	61	52	49	42	37	34	31
95 RN 02 / 14	14	1	0,75	390	3,9		96	89	84	74	68	61	51	48	41
95 RN 02 / 20	20	1,5	1,1	494	4,9		144	136	126	111	101	89	76	71	61
95 RN 02 / 28	28	2	1,5	676	6,2		190	181	169	148	134	120	101	94	83
95 RN 02 / 40	40	3	2,2	924	9,5		273	261	241	211	189	169	145	134	119
95 RN 02 / 52	52	4	3	1.171	11,4		354	336	310	273	249	221	189	174	153

95 RN 03

4 Inch Submersible Pumps (50 Hz)

6 Vanes / 2900 Rpm (CCW) / 98mm Diameter / BSP - NPT 1 1/4" Outlet Connection Diameter / 11 mm Shaft Diameter

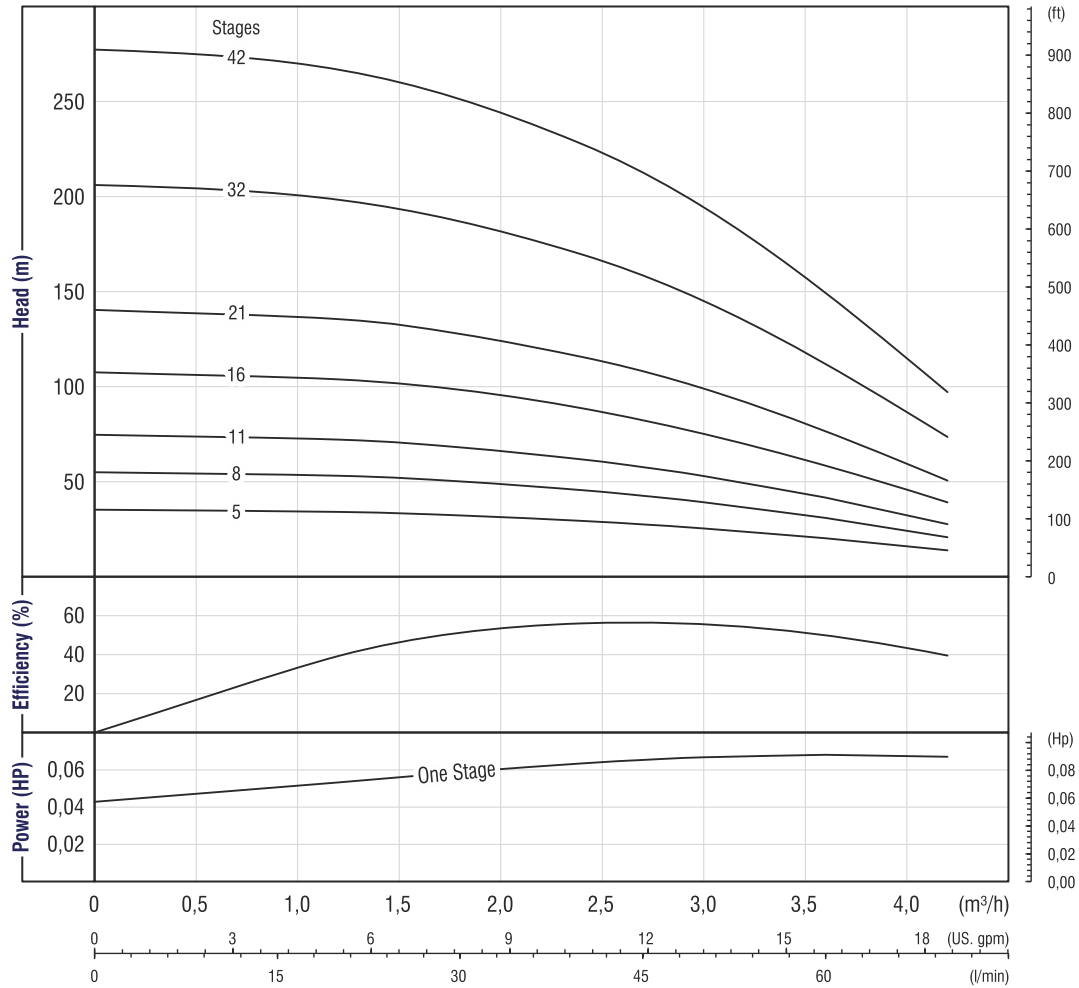

Due to continuous improvement in design we reserve the right to amend specifications or data without prior notice.

Technical Data

Pump Code	Stage	Motor Power		Length mm	Weight kg	m³/h l/min	Head (m)								
		HP	kW				0	1,2	1,8	2,4	2,7	3,0	3,3	3,6	4,2
				0	20		30	40	45	50	55	60	70		
95 RN 03 / 05	5	0,5	0,37	231	2,6	Head (m)	33	32	30	28	26	23	21	19	12
95 RN 03 / 08	8	0,75	0,55	283	3,0		53	51	48	43	40	38	33	30	20
95 RN 03 / 11	11	1	0,75	335	3,5		74	70	66	60	57	51	47	40	26
95 RN 03 / 16	16	1,5	1,1	421	4,3		107	102	96	88	81	75	67	58	38
95 RN 03 / 21	21	2	1,5	509	5,2		141	135	126	115	108	99	89	76	51
95 RN 03 / 32	32	3	2,2	771	8,3		206	200	186	171	159	145	130	111	73
95 RN 03 / 42	42	4	3	948	10,3		280	270	253	229	214	196	175	150	99

95 RN 04

4 Inch Submersible Pumps (50 Hz)

7 Vanes / 2900 Rpm (CCW) / 98mm Diameter / BSP - NPT 1 1/4" Outlet Connection Diameter / 11 mm Shaft Diameter

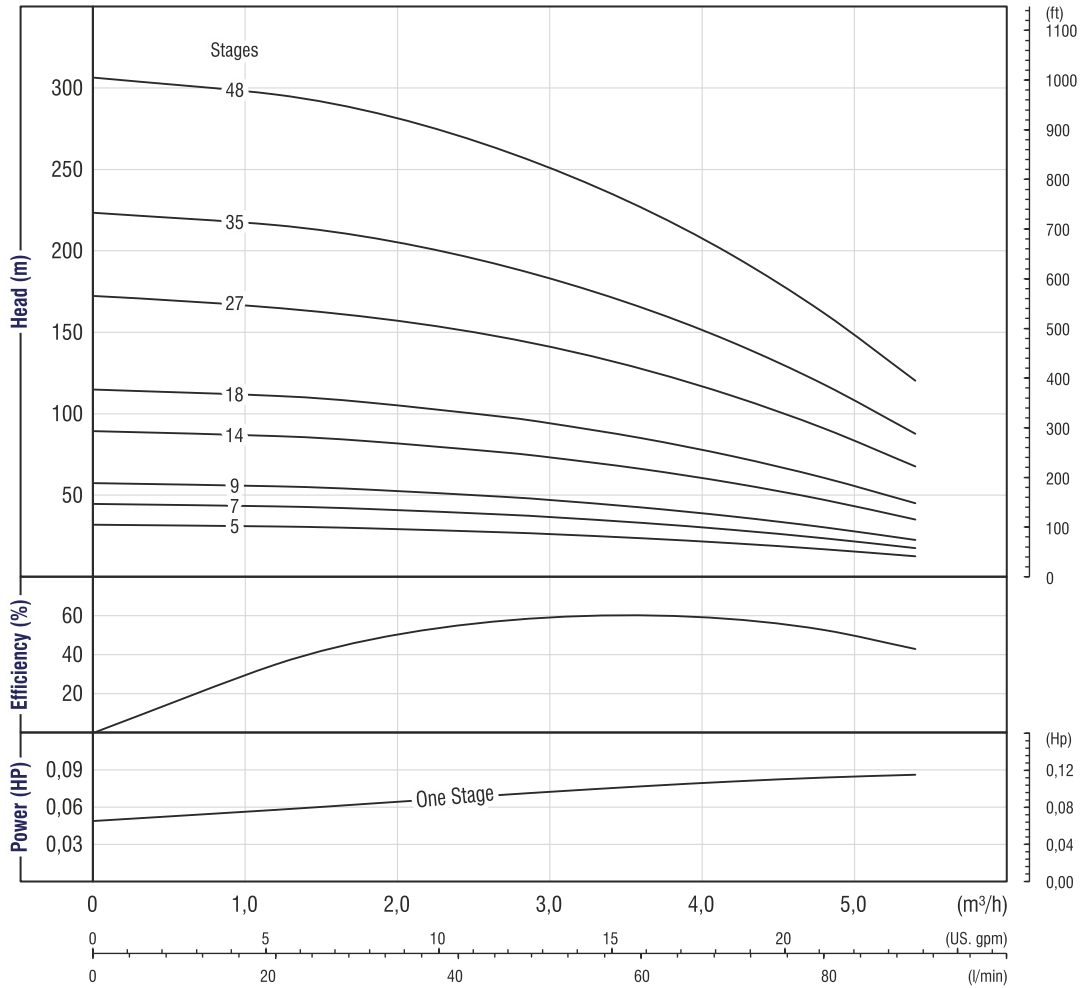

Due to continuous improvement in design we reserve the right to amend specifications or data without prior notice.

Technical Data

Pump Code	Stage	Motor Power		Length mm	Weight kg	m³/h l/min	0	1,2	1,8	2,7	3,0	3,6	4,2	4,8	5,4
		HP	kW				0	20	30	45	50	60	70	80	90
95 RN 04 / 05	5	0,5	0,37	257	2,8	Head (m)	32	31	30	27	26	24	21	17	13
95 RN 04 / 07	7	0,75	0,55	301	3,1		45	43	42	38	37	33	29	24	18
95 RN 04 / 09	9	1	0,75	344	3,4		57	55	53	49	47	43	37	30	23
95 RN 04 / 14	14	1,5	1,1	462	4,2		89	86	83	76	73	66	58	47	35
95 RN 04 / 18	18	2	1,5	538	4,8		115	111	107	98	94	85	74	61	45
95 RN 04 / 27	27	3	2,2	805	7,4		172	166	160	147	141	128	111	91	68
95 RN 04 / 35	35	4	3	972	9,2		223	216	208	191	183	165	144	118	88
95 RN 04 / 48	48	5,5	4	1.291	11,2		306	296	285	261	251	227	197	162	120

95 RN 05

4 Inch Submersible Pumps (50 Hz)

7 Vanes / 2900 Rpm (CCW) / 98mm Diameter / BSP - NPT 1 1/4" Outlet Connection Diameter / 11 mm Shaft Diameter

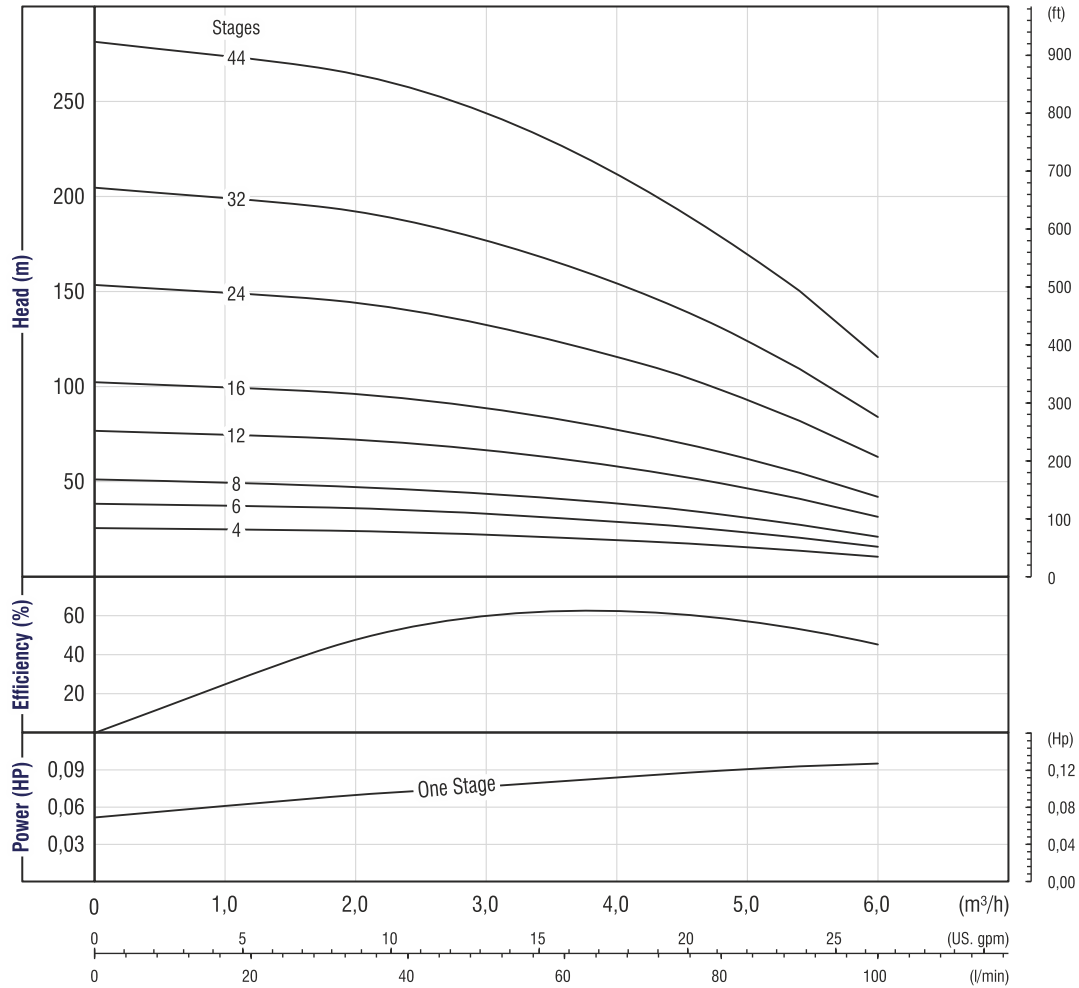

Due to continuous improvement in design we reserve the right to amend specifications or data without prior notice.

Technical Data

Pump Code	Stage	Motor Power		Length mm	Weight kg	m³/h l/min	0	1,8	2,7	3,0	4,2	4,8	5,1	5,4	6,0
		HP	kW				0	30	45	50	70	80	85	90	100
		95 RN 04 / 04	4	0,5	0,37		249	2,5	27	24	23	22	20	17	16
95 RN 04 / 06	6	0,75	0,55	299	3,0	39	37	35	33	29	26	23	21	17	
95 RN 04 / 08	8	1	0,75	348	3,4	51	51	46	45	38	34	30	28	21	
95 RN 04 / 12	12	1,5	1,1	437	4,3	78	74	69	67	57	51	46	41	32	
95 RN 04 / 16	16	2	1,5	547	5,2	103	99	91	89	76	66	61	56	43	
95 RN 04 / 24	24	3	2,2	823	7,9	154	148	138	134	113	99	89	83	64	
95 RN 04 / 32	32	4	3	1.013	10,1	206	195	183	179	151	131	121	111	85	
95 RN 04 / 44	44	5,5	4	1.347	12,7	281	269	251	244	206	180	168	150	118	

95 RN 06

4 Inch Submersible Pumps (50 Hz)

6 Vanes / 2900 Rpm (CCW) / 98mm Diameter / BSP - NPT 2" Outlet Connection Diameter / 11 mm Shaft Diameter

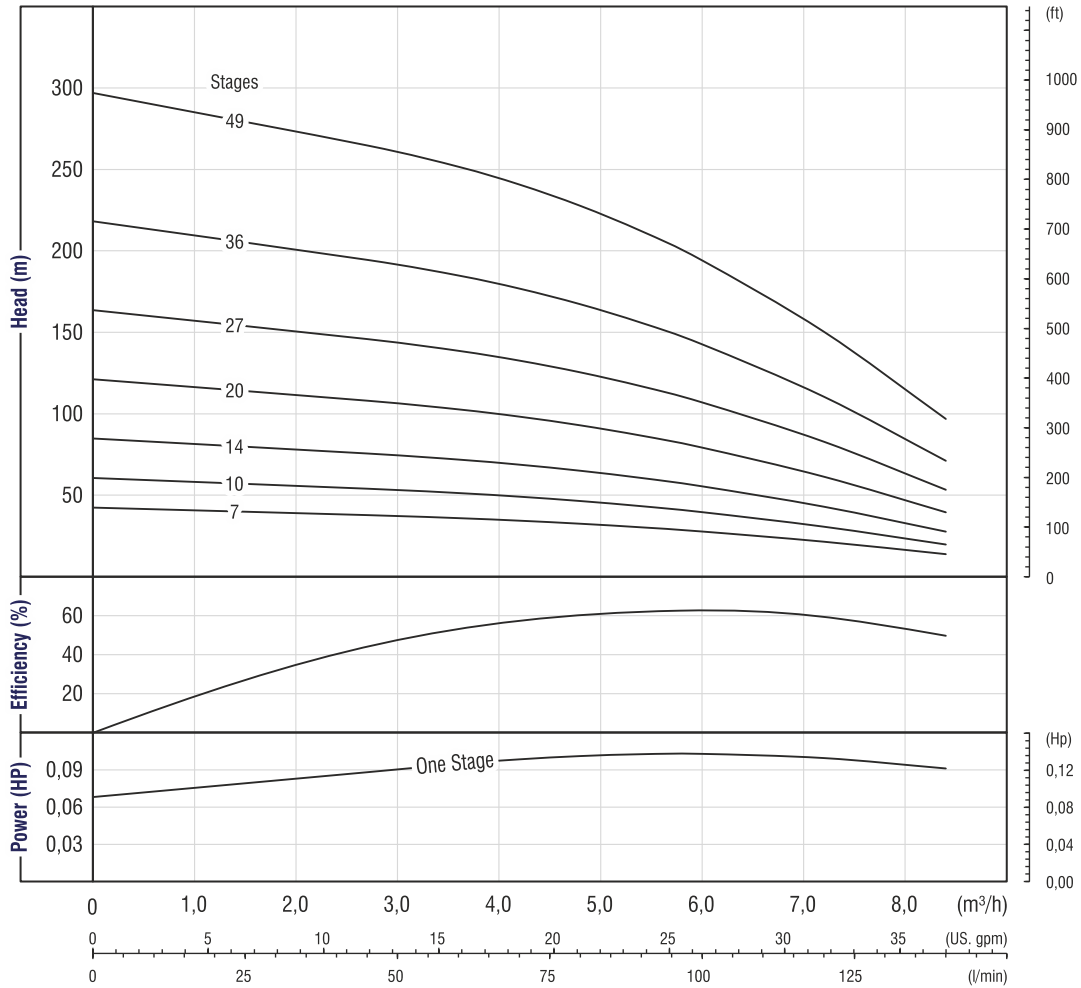

Due to continuous improvement in design we reserve the right to amend specifications or data without prior notice.

Technical Data

Pump Code	Stage	Motor Power		Length mm	Weight kg	m³/h l/min	0	2,7	3,6	4,2	4,8	5,4	6,0	7,2	8,4
		HP	kW				0	45	60	70	80	90	100	120	140
95 RN 06 / 07	7	1	0,75	394	3,9	Head (m)	42	39	37	34	33	30	29	21	14
95 RN 06 / 10	10	1,5	1,1	488	4,8		61	55	52	49	47	43	40	31	20
95 RN 06 / 14	14	2	1,5	613	6,0		86	77	73	70	66	61	56	44	29
95 RN 06 / 20	20	3	2,2	839	7,9		121	110	104	99	94	88	81	61	40
95 RN 06 / 27	27	4	3	1.097	11,1		165	148	141	134	126	119	109	84	54
95 RN 06 / 36	36	5,5	4	1.370	13,9		220	195	186	179	169	158	144	110	71
95 RN 06 / 49	49	7,5	5,5	1.858	17,7		299	266	253	241	230	213	195	150	99

95 RN 08

4 Inch Submersible Pumps (50 Hz)

7 Vanes / 2900 Rpm (CCW) / 98mm Diameter / BSP - NPT 2" Outlet Connection Diameter / 11 mm Shaft Diameter

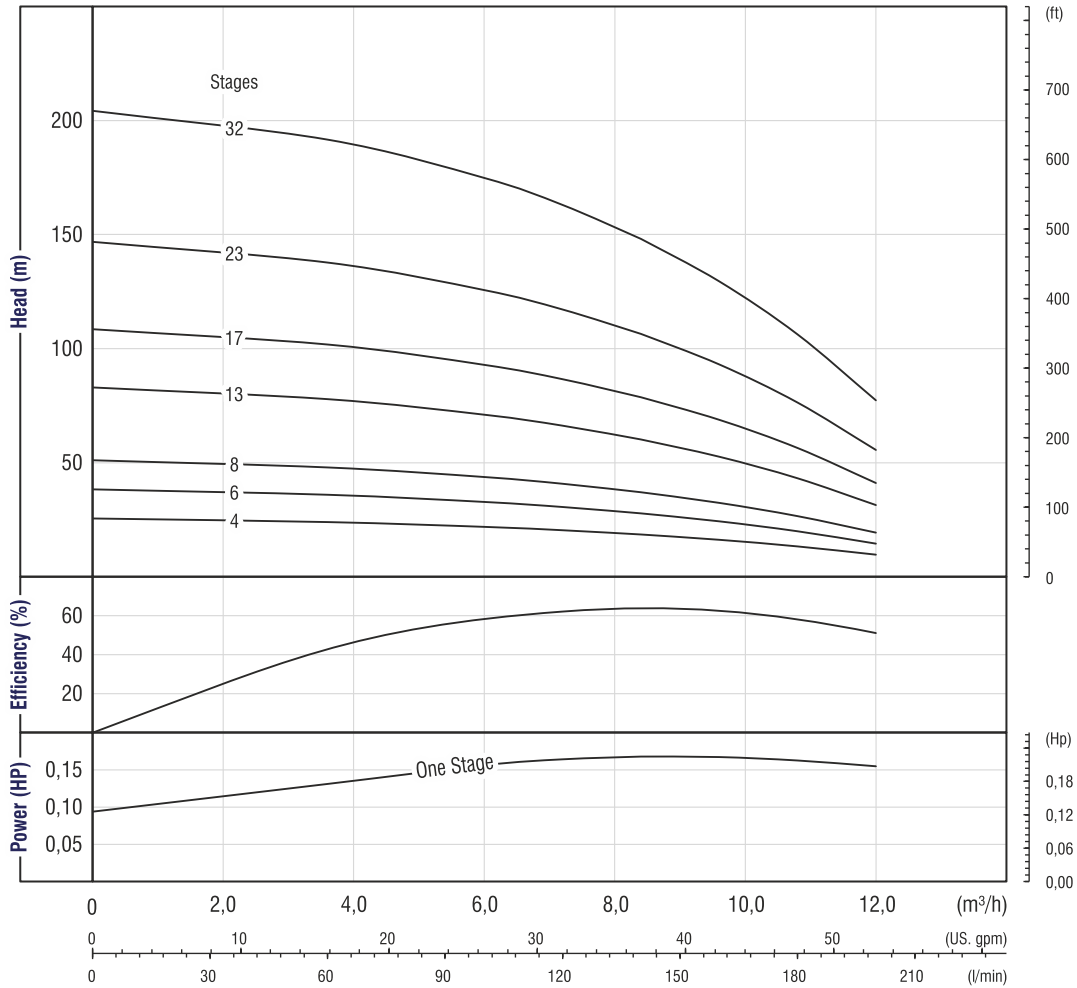

Due to continuous improvement in design we reserve the right to amend specifications or data without prior notice.

Technical Data

Pump Code	Stage	Motor Power		Length mm	Weight kg	m³/h l/min	0	3,6	6,0	7,2	8,4	9,0	9,6	10,8	12,0
		HP	kW				0	60	100	120	140	150	160	180	200
				Head (m)											
95 RN 08 / 04	4	1	0,75	297	3,0	Head (m)	27	24	22	20	20	18	17	13	10
95 RN 08 / 06	6	1,5	1,1	362	3,6		39	37	33	31	29	27	25	20	15
95 RN 08 / 08	8	2	1,5	422	4,3		51	49	45	41	38	36	32	28	21
95 RN 08 / 13	13	3	2,2	579	5,9		84	80	71	67	60	58	54	44	31
95 RN 08 / 17	17	4	3	704	7,1		110	103	94	89	81	75	71	58	41
95 RN 08 / 23	23	5,5	4	969	10,1		149	140	128	119	108	100	94	78	58
95 RN 08 / 32	32	7,5	5,5	1.289	12,8		205	193	176	164	150	141	131	108	79

95 RN 12

4 Inch Submersible Pumps (50 Hz)

6 Vanes / 2900 Rpm (CCW) / 98mm Diameter / BSP - NPT 2" Outlet Connection Diameter / 11 mm Shaft Diameter

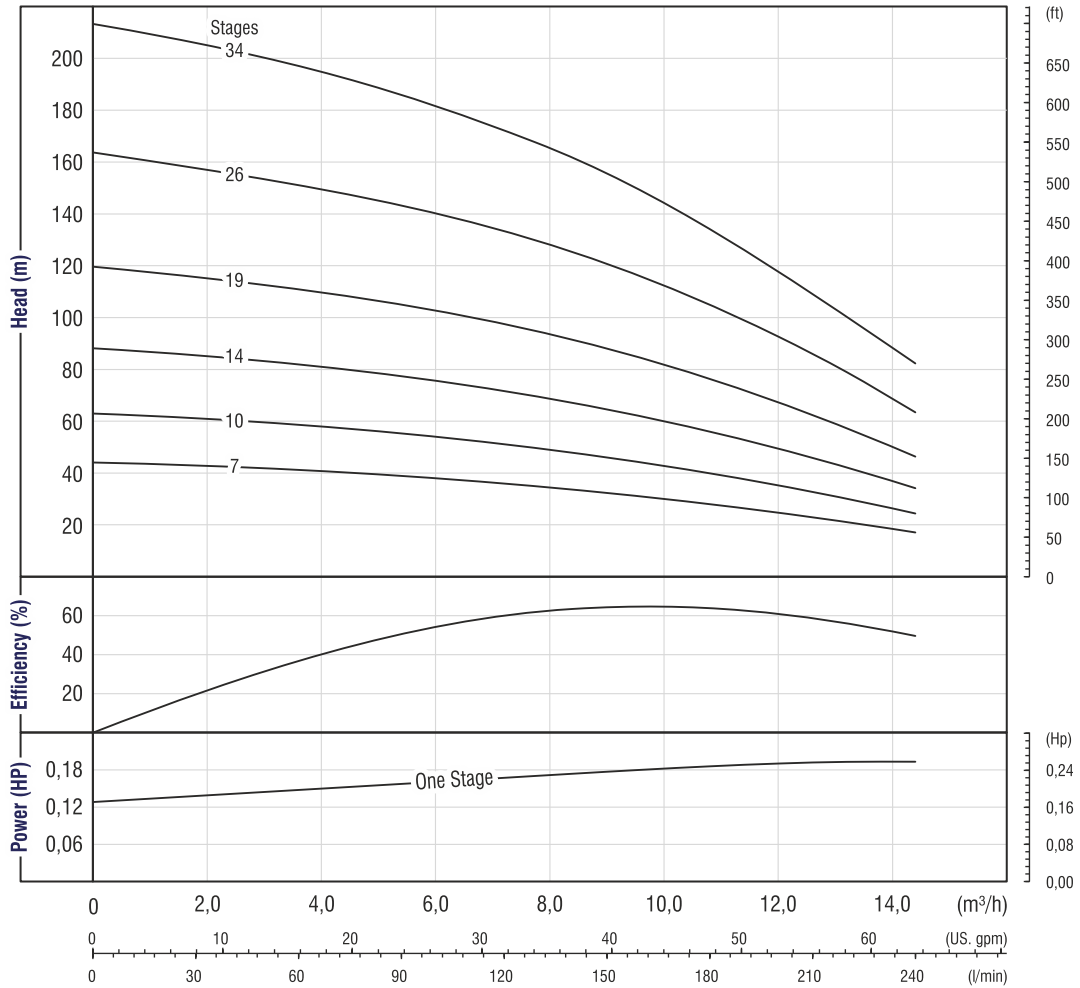

Due to continuous improvement in design we reserve the right to amend specifications or data without prior notice.

Technical Data

Pump Code	Stage	Motor Power		Length mm	Weight kg	m³/h l/min	0	6,0	7,2	8,4	9,6	10,8	12,0	13,2	14,4
		HP	kW				0	100	120	140	160	180	200	220	240
95 RN 12 / 07	7	2	1,5	550	5,7	Head (m)	44	39	37	34	31	29	26	21	18
95 RN 12 / 10	10	3	2,2	711	7,2		63	55	51	49	45	41	37	31	25
95 RN 12 / 14	14	4	3	1.019	9,3		89	77	72	68	62	57	50	42	35
95 RN 12 / 19	19	5,5	4	1.270	13,0		120	104	98	91	85	78	70	60	47
95 RN 12 / 26	26	7,5	5,5	1.645	16,5		165	141	135	126	118	106	94	81	64
95 RN 12 / 34	34	10	7,5	2.070	20,5		215	185	176	165	151	139	121	104	84

95 RN 16

4 Inch Submersible Pumps (50 Hz)

6 Vanes / 2900 Rpm (CCW) / 98mm Diameter / BSP - NPT 2" Outlet Connection Diameter / 11 mm Shaft Diameter

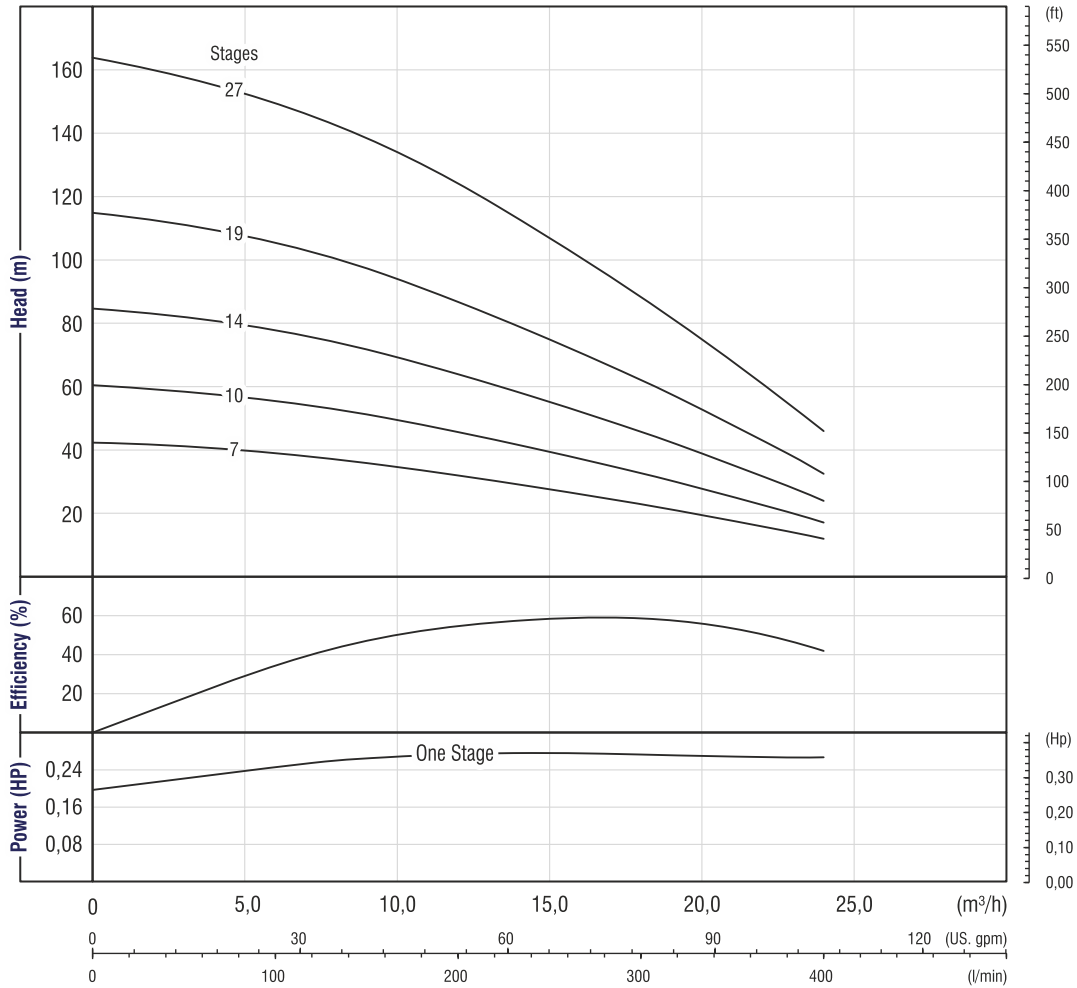

Due to continuous improvement in design we reserve the right to amend specifications or data without prior notice.

Technical Data

Pump Code	Stage	Motor Power		Length mm	Weight kg	m³/h l/min	Head (m)								
		HP	kW				0	7,2	9,6	12,0	14,4	16,8	19,2	22,8	24,0
				0	120		160	200	240	280	320	380	400		
95 RN 16 / 07	7	3	2,2	614	5,8		42	39	36	32	29	26	21	14	12
95 RN 16 / 10	10	4	3	822	7,7		60	55	51	47	41	36	30	21	18
95 RN 16 / 14	14	5,5	4	1.092	10,2		86	77	71	65	58	52	42	31	25
95 RN 16 / 19	19	7,5	5,5	1.435	13,3		116	104	96	88	78	68	58	41	32
95 RN 16 / 27	27	10	7,5	1.975	18,2		164	148	138	124	111	98	80	56	48



hektor
PUMPS



hektor
PUMPS

info@hektorpumps.com / www.hektorpumps.com